

jaga

CLIMATE DESIGNERS

MINI CANAL ELECTRIC

MANUAL

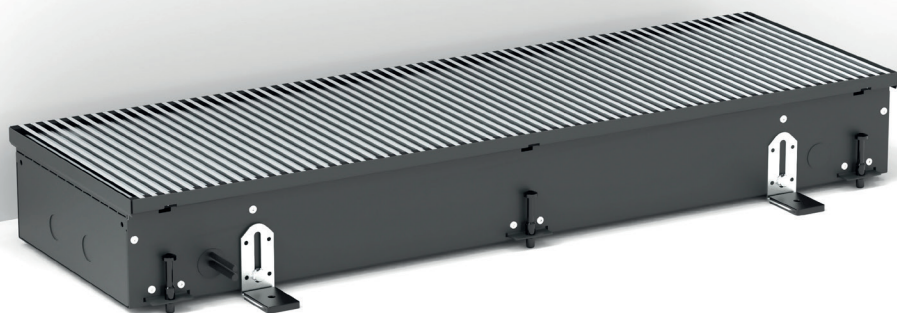

HEATING

CONTENT

1	GENERAL INFORMATION	3
2	SYMBOLS	4
3	PRODUCT DESCRIPTION	5
4	INSTALLATION	7
5	WARRANTY CONDITIONS.....	10

Jaga N.V.
Verbindingslaan 16
B-3590 Diepenbeek

 **+32 (0)11 29 41 11**

Jaga reserves the right to change product specification at any time in line with our policy of continuous improvement and innovation.



Important info

The unit must be installed by a certified installer in accordance with the installation instructions and the local building codes. Please follow this instruction manual and file it somewhere safe! The unit must always be accessible for maintenance and inspection.

Installation must be carried out by certified technicians. Incorrect installation could cause product failure, a reduced performance or an increased noise level.

The warranty is void when:

- The installation, maintenance or operation instructions in this manual are not respected.
- The initial start-up has been carried out before a general cleaning of both the fan and the coil.
- Modifications have been made to the product, before, during or after product installation.
- Maintenance has been carried out by unauthorized people.
- Access to the unit has been restricted due to on-site conditions.

This device is covered by the general warranty conditions of Jaga NV.

1 GENERAL INFORMATION

- Check for any visible damage.
- The unit must be handled with care in order to avoid damage to the unit's interior and exterior parts.
- The unit must remain accessible for inspection and maintenance, the trench must be removable at all times.
- Do not place any objects on the unit.
-  Do not insert objects into the supply and return air openings. .



Unit identification:

The serial number is tagged on unit's right side (on the left if the connections are on the unit's right side).

Use:

- The unit has been designed to function as a fan coil for heating applications; any other use is strictly forbidden. Installing the unit in an explosive environment is prohibited.
- The area must be dry and dust-free, with a temperature between 5°C and 70°C and a relative humidity < 90%.
- The unit is not intended for industrial applications.
- Start-up and commissioning of the unit must be carried out by skilled staff, qualified to work on this type of product.



Maintenance:

- Maintenance must be carried out by qualified technicians.
-   Always use the main disconnect switch to isolate the unit from the mains before carrying out any maintenance or inspection work.
- A dirty grille obstructs the air flow, so clean the grille at regular intervals, depending on the room's purpose and how it's used. The grille should never be disassembled for maintenance and can be easily cleaned by using a vacuum cleaner.
- Do not use solvent- or detergent based products.

Disassembly:

When the unit is not used for long periods of time, it must be disconnected from the mains electrical connection.

Package:

-  Remove the packaging material and put it in the appropriate collection point or recycling facility, in compliance with the local regulations.
-  Do not leave the packaging within reach of children.

Installation

Installation must be carried out by certified technicians. Incorrect installation could cause product failure, a reduced performance or an increased noise level.

- all clearances indicated in the manual must be respected in order to guarantee performance, and to allow installation and maintenance. In case valve packages are to be installed, make sure that there is enough room left.
- Sound travels very easily through hard materials. Soft rubber material can be used to reduce contact noise.

Device installation guidelines:

–Do not insert objects into the supply and return air openings.

Starting:

 Start-up and commissioning of the fancoil must be carried out by skilled staff, qualified to work on this type of product.:

–The unit is positioned correctly.

–The wiring connections are correct and properly tightened.

–The supply voltage is correct.

2 SYMBOLS

 Danger

 Danger: electrical hazard

 Danger: sharp edges / components

 Danger: hot surfaces

 Danger: moving parts

 Attention: important warning

 Environmental safeguard

== VDC - direct current

~ VAC - alternating current

3 PRODUCT DESCRIPTION

3.1. PARTS

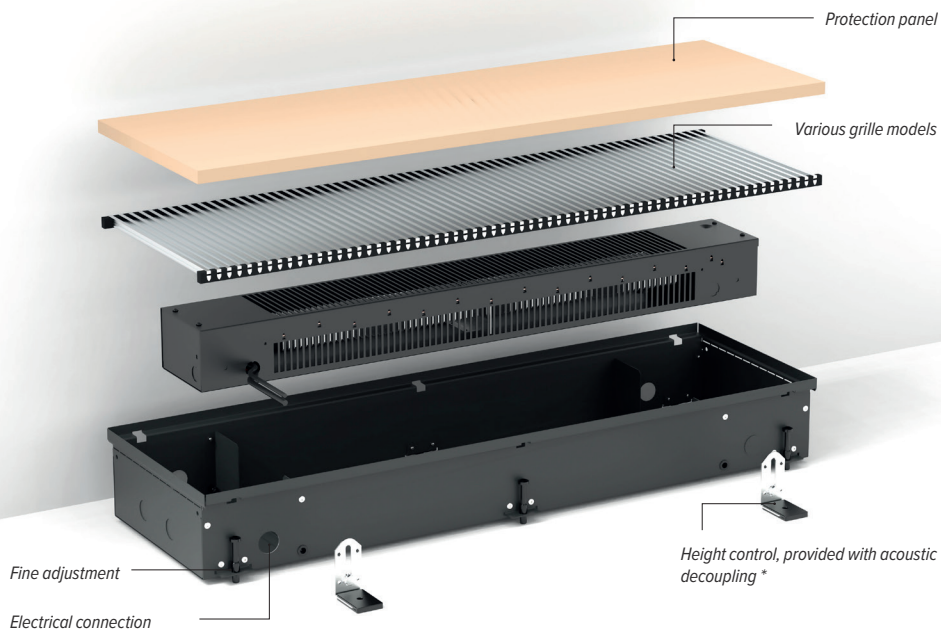

*The height control option is always provided with extra adjusting screws in order to install the duct flat against the window frame. Adjustable (L): 0 - 4.5cm

3.2. USE

This heater includes a manual hi-limit that shuts down the heater if the internal temperature limit is exceeded. When this situation occurs, immediately turn the heater off and inspect for any objects on or adjacent to the heater that may have blocked the airflow or otherwise caused high temperatures to have occurred. If no obstruction is visible, the heater must be checked by a qualified person.

How to reset the manual hi-limit:

- Disconnect the power supply of the heater
- Remove the grille
- Use a vacuum cleaner to remove the dust accumulation inside the heater
- Insert a pointed object in the reset hole
- Push until you hear a click
- Install the grille
- Turn the power back on

3.3. DIMENSIONS in cm (inch)

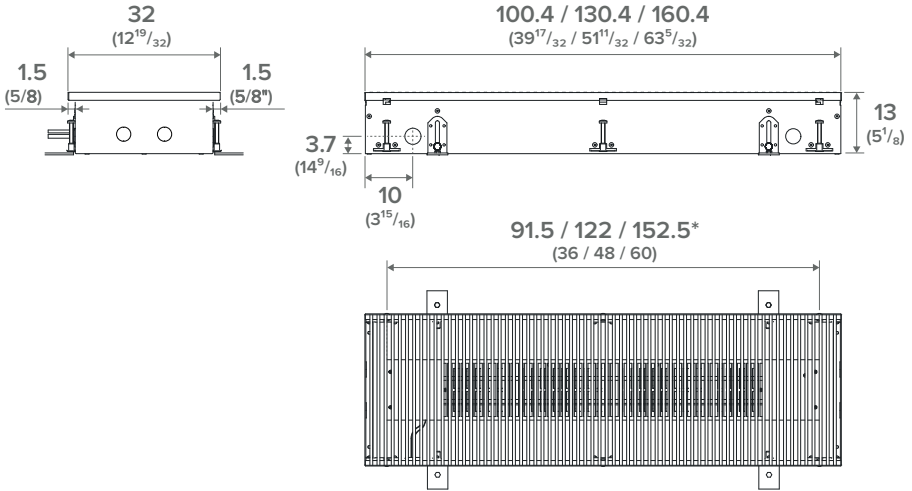

3.4. OUTPUTS

DENSITY	VOLT (V)	L (CM)	100.4 (91.5*)	130.4 (122*)	160.4 (152.5*)
		L (INCH)	39 ¹⁷ / ₃₂ (36*)	51 ¹¹ / ₃₂ (48*)	63 ⁵ / ₃₂ (60*)
High density 250W/ft	120		750W		
	208		750W	1000W	1250W
	277		750W	1000W	1250W
	347		/	1000W	1250W
	600		/	1000W	1250W
	240/208		750/563W	1000/750W	1250/938W
Low density 167W/ft	120		500W	668W	835W
	208		500W	668W	835W
	347		/	668W	835W
	600		/	668W	835W
	240/208		500/375W	668/502W	835/627W
Medium density 200W/ft	120		600W	800W	1000W
	208		600W	800W	1000W
	347		/	800W	1000W
	600		/	800W	1000W
	240/208		600/450W	800/600W	1000/750W

*Dimensions of the heating element

4 INSTALLATION

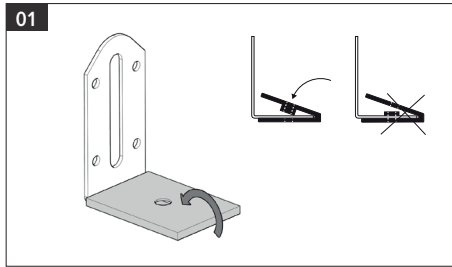

Mount the sound decoupler around each height adjuster.

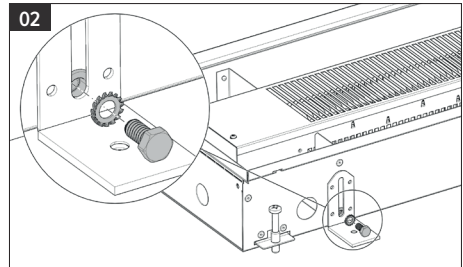

Fix the height adjusters to the casing. Do not completely tighten the bolt.

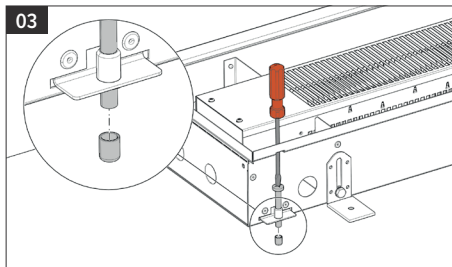

Loosen the control screws and place the caps on top of the screws. You can find the control screws on the side of the device.

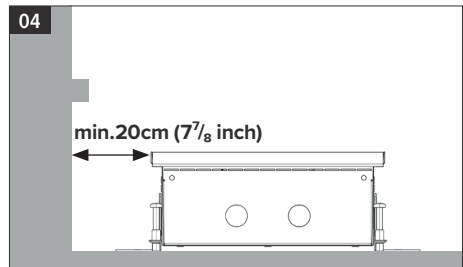

Place the device in the correct position.

⚠ Curtains to the floor: Place the device at least 20 cm from the window.

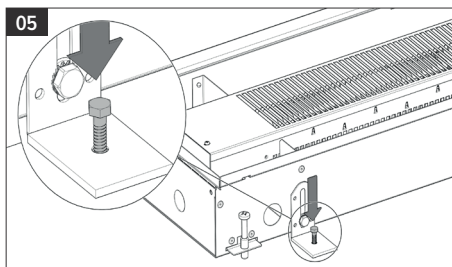

Fix the device to the floor, thanks to the height control in combination with the rubber sound decouplers.

⚠ Use the correct plug for your floor type.

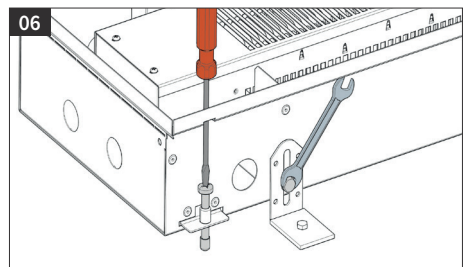

Use the control screws to adjust the unit to the desired height. Secure the height.

⚠ Make sure that the top of the device is aligned with the finished floor.

EN

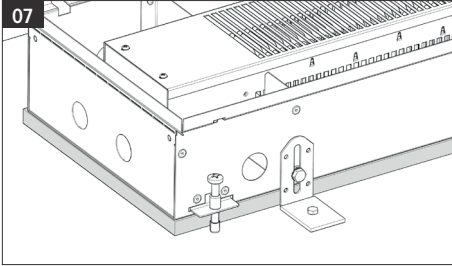

⚠ If the device is not mounted directly on the floor, the space under the device must be filled.

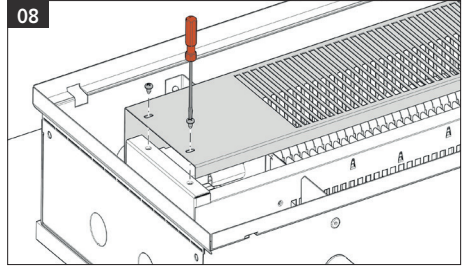

Remove the heating unit's cover plate.

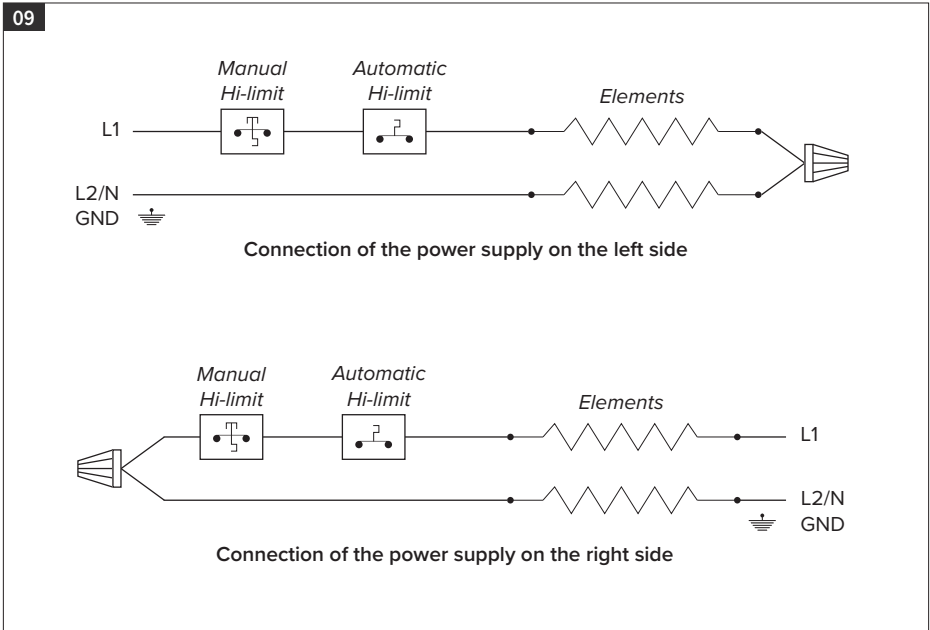

Electrical connection

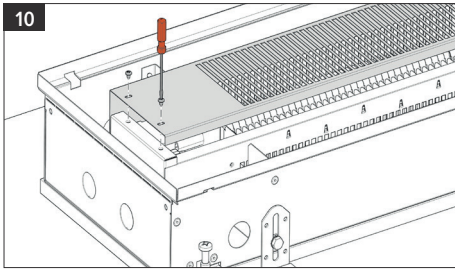

10 Mount the heating unit's cover plate.

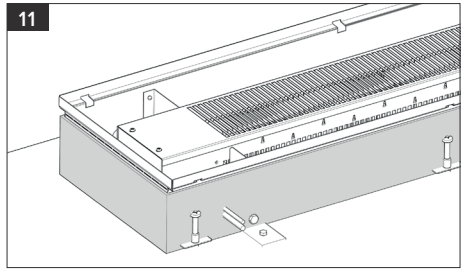

11 **⚠** If screed is used the device needs to be completely insulated in order to protect the device from voltage differences.

EN

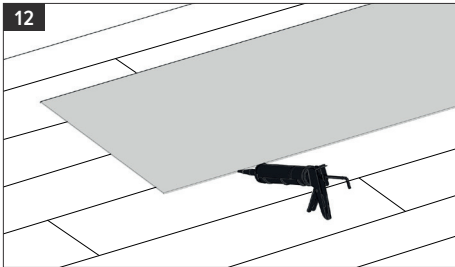

12 Place the screed floor and finish.

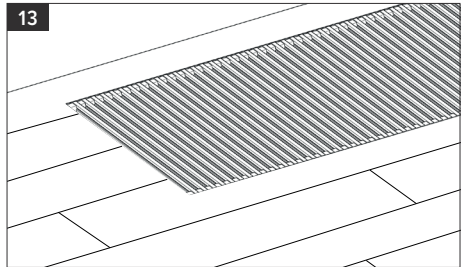

13 Install the grille.

5 WARRANTY CONDITIONS

1. The guarantee is valid only if the equipment is properly and correctly used, by its first owner and if installed in accordance with the norms and instructions as stipulated in the instruction leaflet and the current practices.
2. The guarantee only applies to the equipment and the spare parts. Jaga has the choice between repair and replacement of the equipment or the spare parts. If there has been a change in the model, Jaga is authorised to replace the guaranteed equipment with an equivalent equipment or equivalent spare parts. In those cases where the guarantee claim is received, during the first six months after the start of the guarantee, on all labour and transport costs.
3. The period of guarantee is mentioned in this certificate. A repair or replacement does not change anything to the original period of guarantee.
4. No guarantee is granted on equipment or spare parts lacking information concerning type or series, or on equipment where this information has been removed or altered, or on equipment that has been repaired or modified by persons not authorized by Jaga.
5. The customer is responsible for the damage in the cases where the damage is due to errors of placement, fittings, electrical connections, faulty or damaged electrical installations or appliances, erroneous voltage or hydraulic pressure and all other errors not related to the product delivered by Jaga. The guarantee is also revoked when nonsuited parts are applied. The guarantee for our heat exchangers not valid if they are emptied at set times or during a certain period, or if they are heated by means of industrial water, steam or water saturated by great quantities of oxygen. The quality of the system water has to be in accordance with the VDI 2035-2 directives. The buyer will make every effort to prevent damage to the device by avoiding both dust and moisture. This means that the customer has to cover the device in case of further construction works in order to ensure that the devices remain dust-free. The guarantee is also revoked when the heat exchangers are placed in aggressive atmospheric surroundings (ammonia, caustic substances). Lacquered radiators should not be used in humid spaces. Lacquered radiators should not be used in the following areas: above a bath with a built-in shower unit, in a shower cubical or next to it, in a swimming pool (chlorine) or in a sauna.
6. Jaga does not give a guarantee on faulty equipment due to incorrect handling and/or use of the equipment, the dropping of the equipment or the transport without the necessary precautions, or for all equipment that is built in, in a way that it cannot be reached normally. The guarantee is valid only if the equipment is properly and correctly used, by its first owner and if installed in accordance with the norms and instructions as stipulated in the instruction leaflet and the current practices.
7. In all cases where the guarantee is granted but where the intervention occurs later than 6 months after the start of the guarantee, and in all other cases, labour and transportation costs are calculated according to scales set by Jaga. Customers can get information on those scales either from our sales administration personnel, or from the maintenance engineer.
8. All interventions not covered by the guarantee have to be paid in cash to the maintenance engineer.
9. The guarantee starts on the date of the invoice. If the invoice is not available, the serial number or the date of production prevails.
10. Only the courts of judicial district Hasselt (Belgium) are authorised to deal with disputes arising from this guarantee. It will apply Belgian law even when sales involved are subjects of EU member states as well as non-EU member countries.